

20 [18]

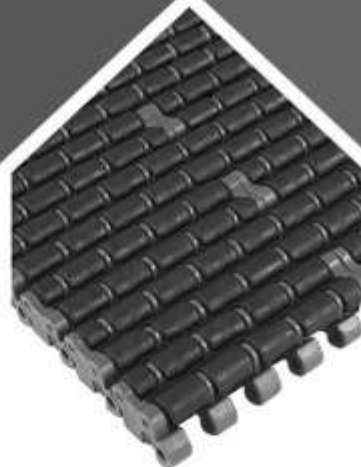

CADENAS PLASTICAS



Movex[®]
PRODUCT CATALOG

Movex[®]

Global Thinking, Local acting.

Tu negocio está avanzando hacia el futuro.

Movex diseña y fabrica componentes de alta calidad para la comida, industrias de bebidas, envases, automotriz y automatización.

Movex satisface sus necesidades de productos estándar y personalizados en una dinámica de manera receptiva, proporcionando el mejor diseño y soporte posventa.

La innovación y el nivel de servicio son los objetivos de una ingeniería y ventas calificadas con el objetivo de presentar Movex como un proveedor de excelencia para todos los clientes.

A través de una red de distribución que abarca todo el mundo, Movex ofrece constante evolución en diseño, rendimiento y servicio.

Calidad y Pasión a su servicio.



1874 TAB Catena curvilinea Sideflexing chain / Kurvengängige Scharnierbandkette

Backflex radius min.: 260 mm

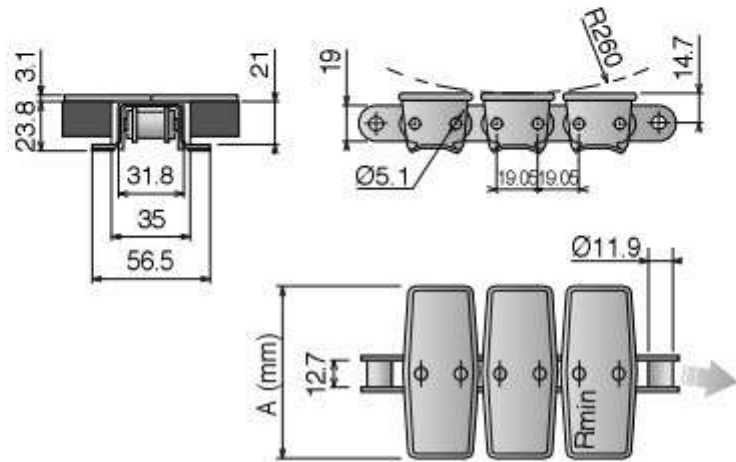

Standard length roller chain: 160 Pitches

Tab System

10 feet
3.048 m
80 links









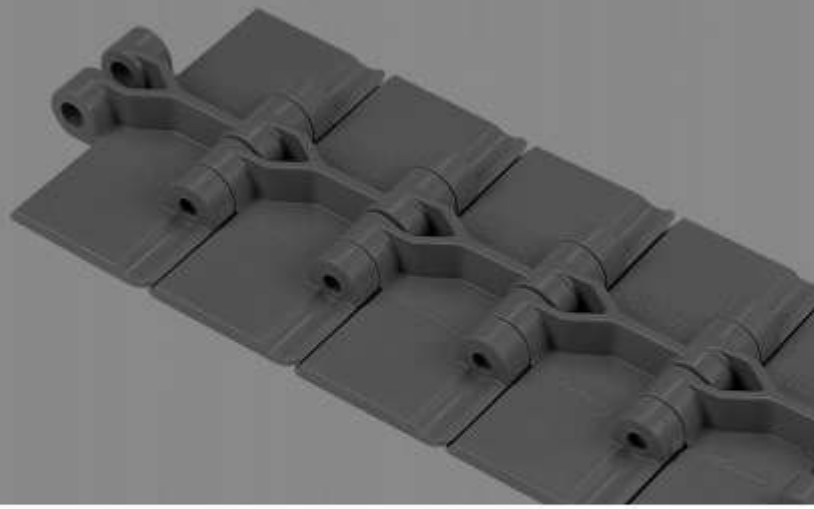







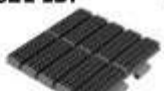

















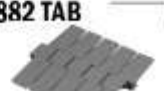

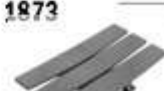









SPROCKET
ASA 60
Standard on market













pg. 159/164

pg. 473-476

Article-Nr.	Ref.	A (Plate Width) mm.	R mm.	Weight kg/m.	Surface finish µm.	Max working load (N)	Plate Thickness mm.
<i>Austenitic Stainless Steel</i>							
10220202	SS 1874 TAB K325	82,5	381	4,20	0,5	4500	3,1
10220205	SS 1874 TAB K450	114,3	381	4,80	0,5		
10220206	SS 1874 TAB K600	152,4	457	5,70	0,5		
10220207	SS 1874 TAB K750	190,5	610	6,40	0,5		



820  Pag 31-32	820 V  Pag 33	820 Plastic pin  Pag 33	828  Pag 34	831  Pag 35	821  Pag 36
821 GT  Pag 37	821 LBP  Pag 38	8257  Pag 39	8257 GT  Pag 40	8257 IRP  Pag 41	878 TAB  Pag 42
879 M  Pag 43	879 TAB  Pag 44	888  Pag 45	888 GT  Pag 46	880 M  Pag 47	880 TAB  Pag 48
880 V TAB  Pag 49	880 TAB Plastic pin  Pag 49	880 B  Pag 50	880 TAB BO  Pag 51	882 M  Pag 52	882 M GT  Pag 53
882 M LBP  Pag 54	882 TAB  Pag 55	882 TAB GT  Pag 56	882 TAB LBP  Pag 57	1873  Pag 58	1873 GT  Pag 59
1873 GRIPPER GS1  Pag 60	1873 GRIPPER GS2  Pag 61	1873 GRIPPER GS4  Pag 62	1873 D-SHAPE  Pag 63	1873 MX1  Pag 64	1873 MX2  Pag 65
878 GRIPPER GS1  Pag 66	878 GRIPPER GS2  Pag 66	878 GRIPPER GS4  Pag 66	1843  Pag 67	SP 1883  Pag 68	SP 1883 GT  Pag 69
CC 600  Pag 70	CC 600 TAB  Pag 70	CC 600 D  Pag 71	CC 600 D TAB  Pag 71	CC 1400  Pag 72	CC 1400 TAB  Pag 72

1701 TAB OP  Pag 73	1701 TAB OPF  Pag 74	1706  Pag 75	1706 TAB  Pag 75	765 NO GAP  Pag 76	43 MF  Pag 77
63 MF  Pag 77	83 MF  Pag 77	103 MF  Pag 77	83 M  Pag 78	140 M  Pag 78	83 M/PII  Pag 79

820

Catena rettilinea
Straight running chain / Geradegängige Scharnierbandkette

Pins: Stainless Steel | Backflex radius min.: 50 mm

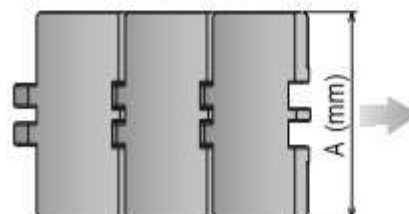
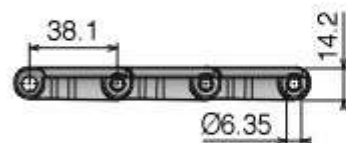
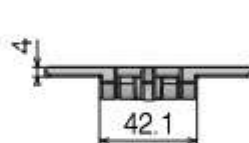

80 links



pg. 88-96/104



pg. 464-471

Article-Nr.	Ref.	A (Plate Width) mm	Weight kg/m	Max working load (N)	Material
11010102	LF 820 K325	82,5	0,89	1625	LF
11010103	LF 820 K330	83,8	0,90		
11010104	LF 820 K350	88,9	0,91		
11010114	LF 820 K400	101,6	0,95		
11010105	LF 820 K450	114,3	1,00		
11010106	LF 820 K600	152,4	1,22		
11010107	LF 820 K750	190,5	1,43		
11010302	MX 820 K325	82,5	0,89	1260	MX
11010303	MX 820 K330	83,8	0,90		
11010304	MX 820 K350	88,9	0,91		
11010314	MX 820 K400	101,6	0,95		
11010305	MX 820 K450	114,3	1,00		
11010306	MX 820 K600	152,4	1,22		
11010307	MX 820 K750	190,5	1,43		
11012502	MPX 820 K325	82,5	0,89	1625	MPX
11012503	MPX 820 K330	83,8	0,90		
11012504	MPX 820 K350	88,9	0,91		
11012514	MPX 820 K400	101,6	0,95		
11012505	MPX 820 K450	114,3	1,00		
11012506	MPX 820 K600	152,4	1,22		
11012507	MPX 820 K750	190,5	1,43		

820

Catena rettilinea
Straight running chain / Geradegängige Scharnierbandkette

Pins: Stainless Steel | Backflex radius min.: 50 mm

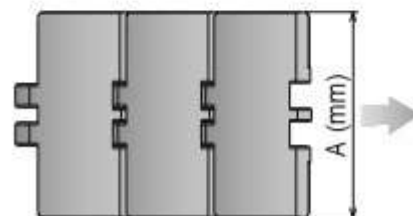
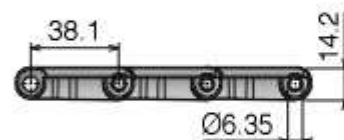
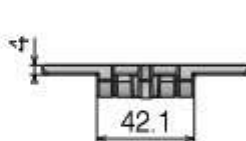

80 links



pg. 88-89-96/104



pg. 464-471

Article-Nr.	Ref.	A (Plate Width) mm	Weight kg/m	Max working load (N)	Material
11011602	DKM 820 K325	82,5	0,89	1625	DKM
11011603	DKM 820 K330	83,8	0,90		
11011604	DKM 820 K350	88,9	0,91		
11011614	DKM 820 K400	101,6	0,95		
11011605	DKM 820 K450	114,3	1,00		
11011606	DKM 820 K600	152,4	1,22		
11011607	DKM 820 K750	190,5	1,43		
11011702	MWX 820 K325	82,5	0,89	1625	MWX
11011703	MWX 820 K330	83,8	0,90		
11011704	MWX 820 K350	88,9	0,91		
11011714	MWX 820 K400	101,6	0,95		
11011705	MWX 820 K450	114,3	1,00		
11011706	MWX 820 K600	152,4	1,22		
11011707	MWX 820 K750	190,5	1,43		

820 V Catena rettilinea Straight running chain / Geradegängige Scharnierbandkette

Pins: Stainless Steel | Backflex radius min.: 50 mm

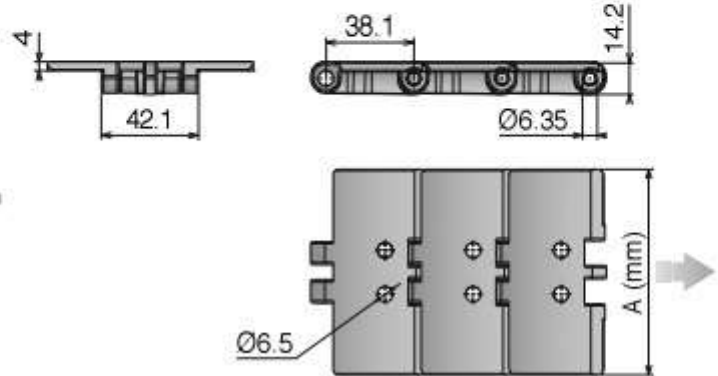

Article-Nr.	Ref.	A (Plate Width) mm	Weight kg/m	Max working load (N)	Material
11550102	LF 820 V2 K325	82,5	0,89	1625	LF
11550105	LF 820 V2 K450	114,3	1,00		
11550302	MX 820 V2 K325	82,5	0,89	1260	MX
11550305	MX 820 V2 K450	114,3	1,00		

820 Plastic pin Catena rettilinea con perno in plastica Straight running chain with plastic pin / Geradegängige Scharnierbandkette mit plastic bolzen

Pins: Plastic | Backflex radius min.: 50 mm

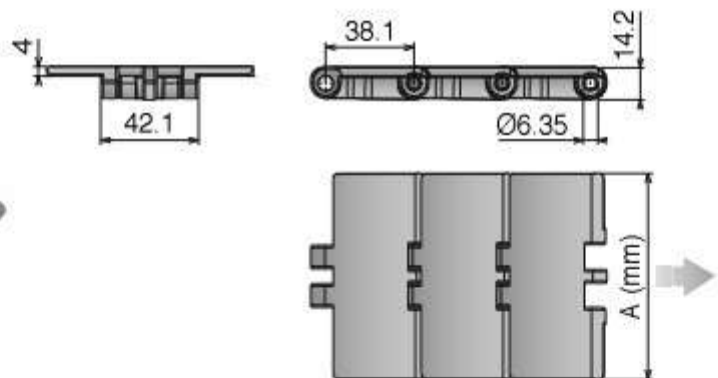

Article-Nr.	Ref.	A (Plate Width) mm	Weight kg/m	Max working load (N)	Material
11630102	LF 820 K325	82,5	0,69	650	LF
11630105	LF 820 K450	114,3	0,80		

828

Catena rettilinea
Straight running chain / Geradegängige Scharnierbandkette

Pins: Stainless Steel | Backflex radius min.: 50 mm

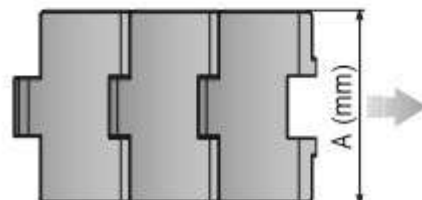
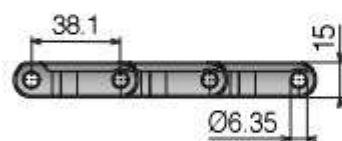
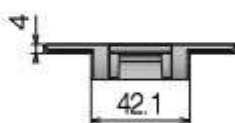

80 links

pg. 90-91/104

pg. 464-471

Article-Nr.	Ref.	A (Plate Width) mm	Weight kg/m	Max working load (N)	Materia
11020102	LF 828 K325	82,5	1,07	2320	LF
11020103	LF 828 K330	83,8	1,13		
11020302	MX 828 K325	82,5	1,07	1860	MX
11020303	MX 828 K330	83,8	1,13		
11022502	MPX 828 K325	82,5	1,07	2320	MPX
11022503	MPX 828 K330	83,8	1,13		
11021602	DKM 828 K325	82,5	1,07	2320	DKM
11021603	DKM 828 K330	83,8	1,13		
11021702	MWX 828 K325	82,5	1,07	2320	MWX
11021703	MWX 828 K330	83,8	1,13		

831

Catena rettilinea
Straight running chain / Geradegängige Scharnierbandkette

Pins: Stainless Steel | Backflex radius min.: 50 mm

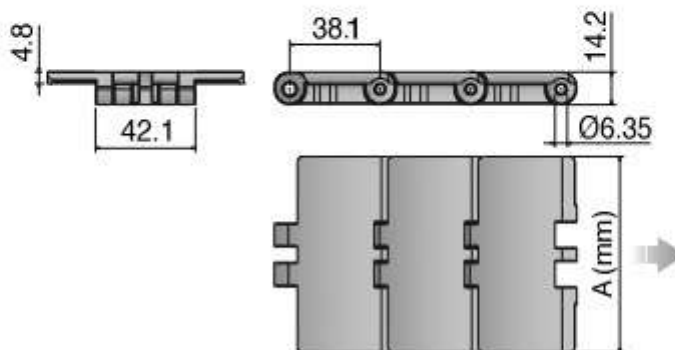

Article-Nr.	Ref.	A (Plate Width) mm	Weight kg/ m	Max working load (N)	Material
11030102	LF 831 K325	82,5	1,00	1625	LF
11030105	LF 831 K450	114,3	1,28		
11030107	LF 831 K750	190,5	1,80		
11030302	MX 831 K325	82,5	1,00	1260	MX
11030305	MX 831 K450	114,3	1,28		
11030307	MX 831 K750	190,5	1,80		
11032502	MPX 831 K325	82,5	1,00	1625	MPX
11032505	MPX 831 K450	114,3	1,28		
11032507	MPX 831 K750	190,5	1,80		
11031602	DKM 831 K325	82,5	1,00	1625	DKM
11031605	DKM 831 K450	114,3	1,28		
11031607	DKM 831 K750	190,5	1,80		
11031702	MWX 831 K325	82,5	1,00	1625	MWX
11031705	MWX 831 K450	114,3	1,28		
11031707	MWX 831 K750	190,5	1,80		

821

Catena rettilinea
Straight running chain / Geradegängige Scharnierbandkette

Pins: Stainless Steel | Backflex radius min.: 50 mm

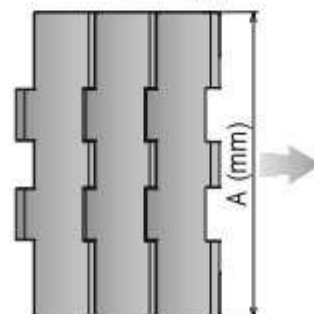
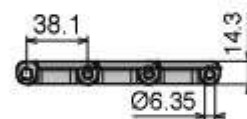
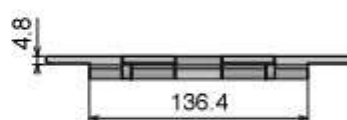

Article-Nr.	Ref.	A (Plate Width) mm	Weight kg/m	Max working load (N)	Material
11040107	LF 821 K750	190,5	2,55	2770	LF
11040108	LF 821 K1000	254,0	3,05		
11040109	LF 821 K1200	304,8	3,35		
11040307	MX 821 K750	190,5	2,55	2200	MX
11040308	MX 821 K1000	254,0	3,05		
11040309	MX 821 K1200	304,8	3,35		
11042507	MPX 821 K750	190,5	2,55	2770	MPX
11042508	MPX 821 K1000	254,0	3,05		
11042509	MPX 821 K1200	304,8	3,35		
11041607	DKM 821 K750	190,5	2,55	2770	DKM
11041608	DKM 821 K1000	254,0	3,05		
11041609	DKM 821 K1200	304,8	3,35		
11041707	MWX 821 K750	190,5	2,55	2770	MWX
11041708	MWX 821 K1000	254,0	3,05		
11041709	MWX 821 K1200	304,8	3,35		

821 GT Catena rettilinea Straight running chain / Geradegängige Scharnierbandkette

Pins: Stainless Steel | Backflex radius min.: 50 mm | TPE Rubber: 75 ShA

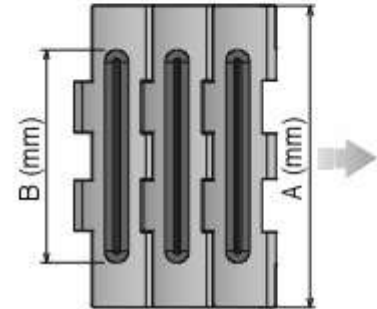
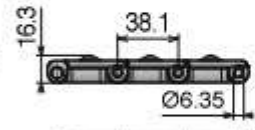
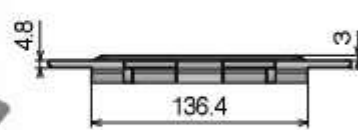

10 feet
3.048 m
80 links

pg. 86/105

pg. 464-471

Article.Nr.	Ref.	A (Plate Width) mm	B (Rubber Width) mm	Weight kg/ m	Max working load (N)	Material
11050107	LF 821 GT K750	190,5	134,0	2,55	2770	LF
11050108	LF 821 GT K1000	254,0	192,0	3,05		
11050109	LF 821 GT K1200	304,8	252,0	3,35		
11050307	MX 821 GT K750	190,5	134,0	2,55	2200	MX
11050308	MX 821 GT K1000	254,0	192,0	3,05		
11050309	MX 821 GT K1200	304,8	252,0	3,35		

821 LBP

Catene in plastica / Plastic chains / Scharnierbandketten aus Kunststoff

821 LBP

Catena rettilinea
Straight running chain / Geradegängige Scharnierbandkette

Pins: Stainless Steel | Backflex radius min.: 150 mm

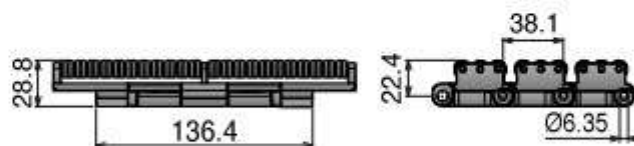

K750

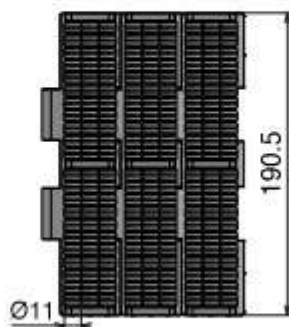

K1000

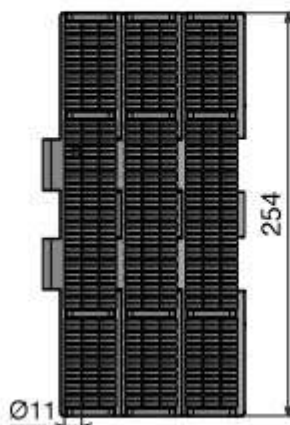

K1200

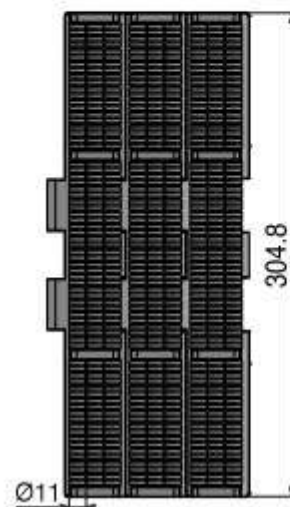

 5 feet 1.524 m	 pg. 86/105	 pg. 464-471
40 links		

Article-Nr.	Ref.	A/ Plate Width mm	Weight kg/ m	Max working load (N)	Material
11060107	LFA 821 LBP K750	190,5	5,70	2770	LFA
11060108	LFA 821 LBP K1000	254,0	7,05		
11060109	LFA 821 LBP K1200	304,8	8,21		



8257

Catena rettilinea
Straight running chain / Geradegängige Scharnierbandkette

Pins: Stainless Steel | Backflex radius min.: 50 mm

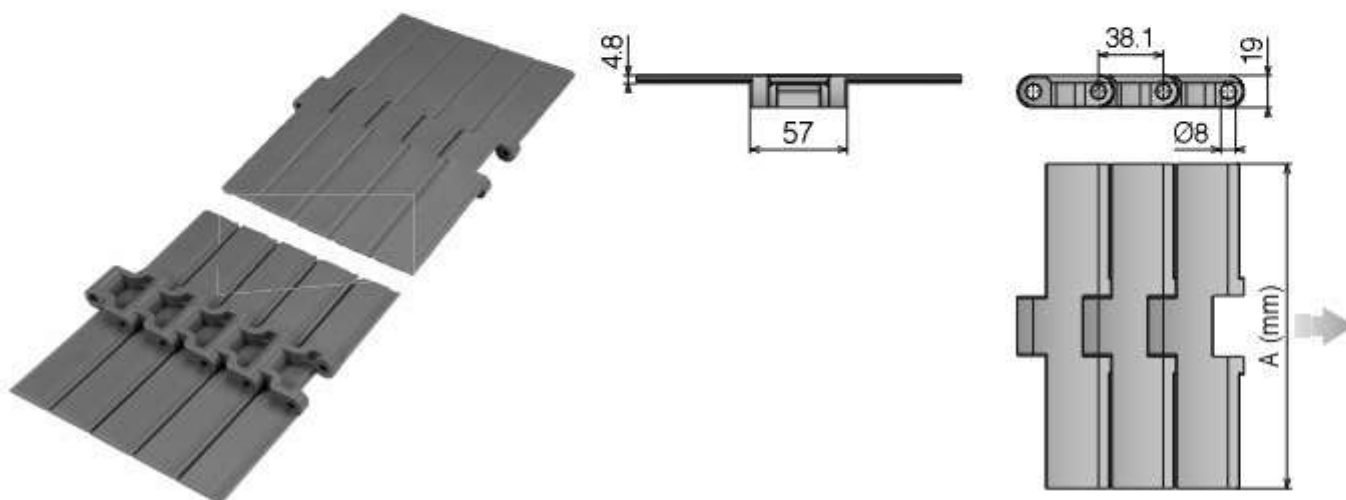

Article-Nr.	Ref.	A/ Plate Width mm	Weight kg/m	Max working load (N)	Material
11070107	LF 8257 K750	190,5	2,55	3830	LF
11070108	LF 8257 K1000	254,0	3,05		
11070109	LF 8257 K1200	304,8	3,35		
11070307	MX 8257 K750	190,5	2,55	3050	MX
11070308	MX 8257 K1000	254,0	3,05		
11070309	MX 8257 K1200	304,8	3,35		
11072507	MPX 8257 K750	190,5	2,55	3830	MPX
11072508	MPX 8257 K1000	254,0	3,05		
11072509	MPX 8257 K1200	304,8	3,35		
11071607	DKM 8257 K750	190,5	2,55	3830	DKM
11071608	DKM 8257 K1000	254,0	3,05		
11071609	DKM 8257 K1200	304,8	3,35		
11071707	MWX 8257 K750	190,5	2,55	3830	MWX
11071708	MWX 8257 K1000	254,0	3,05		
11071709	MWX 8257 K1200	304,8	3,35		

8257 GT

Catene in plastica / Plastic chains / Scharnierbandketten aus Kunststoff

8257 GT

Catena rettilinea
Straight running chain / Geradegängige Scharnierbandkette

Pins: Stainless Steel | Backflex radius min.: 50 mm | TPE Rubber: 75 Sha

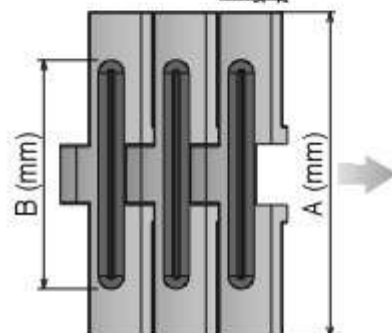
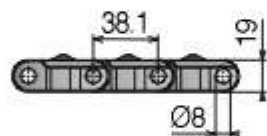
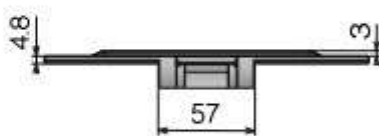

Article-Nr	Ref	A (Plate Width) mm	B (Rubber Width) mm	Weight kg/m	Max working load (N)	Material
11080107	LF 8257 GT K750	190,5	134,0	2,55	3830	LF
11080108	LF 8257 GT K1000	254,0	192,0	2,60		
11080109	LF 8257 GT K1200	304,8	252,0	2,95		
11080307	MX 8257 GT K750	190,5	134,0	2,55	3050	MX
11080308	MX 8257 GT K1000	254,0	192,0	2,60		
11080309	MX 8257 GT K1200	304,8	252,0	2,95		

8257 LBP

Catena rettilinea
Straight running chain / Geradegängige Scharnierbandkette

Pins: Stainless Steel | Backflex radius min.: 200 mm

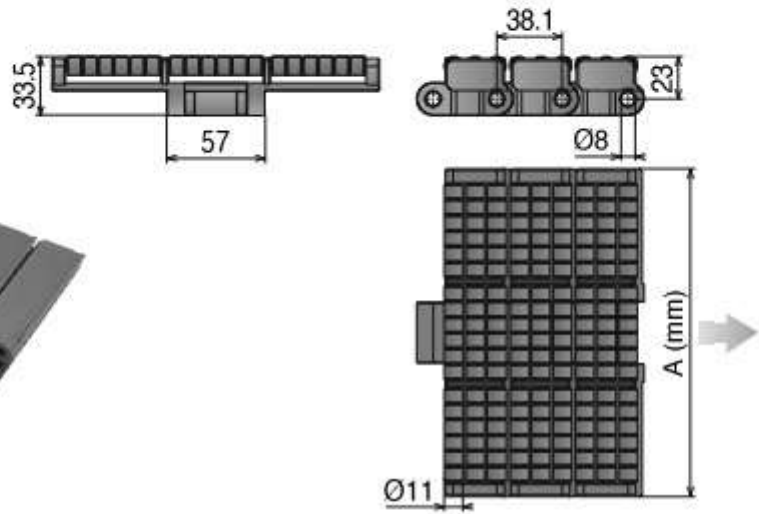

Article-Nr.	Ref.	A (Plate Width) mm	Weight kg/m	Max working load (N)	Material
11090107	LFA 8257 LBP K750	190,5	5,65	3830	LFA
11090108	LFA 8257 LBP K1000	254,0	7,16		
11090109	LFA 8257 LBP K1200	304,8	8,05		

878 TAB

Catene in plastica / Plastic chains / Scharnierbandketten aus Kunststoff

878 TAB

Catena curvilinea
Sideflexing chain / Kurvengängige Scharnierbandkette

Pins: Stainless Steel | Backflex radius min.: 40 mm

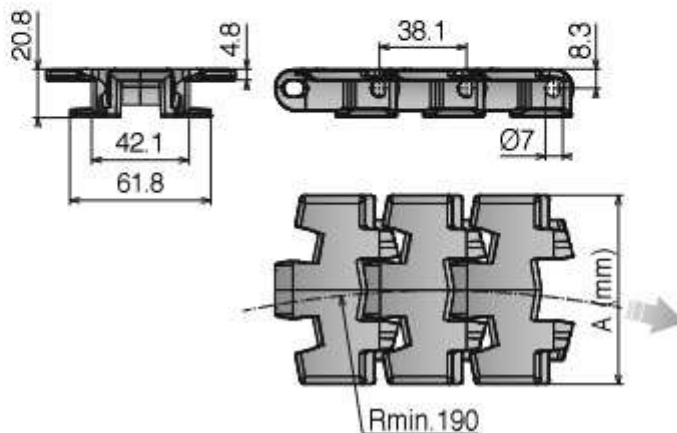

Tab System



Article-Nr	Ref	A (Plate Width) mm	Weight kg/m	Max working load (N)	Material
11190102	LF 878 TAB K325	82,5	1,06	2200	LF
11190105	LF 878 TAB K450	114,3	1,18		
11190302	MX 878 TAB K325	82,5	1,06	1750	MX
11190305	MX 878 TAB K450	114,3	1,18		
11192502	MPX 878 TAB K325	82,5	1,06	2200	MPX
11191602	DKM 878 TAB K325	82,5	1,06	2200	DKM
11191702	MWX 878 TAB K325	82,5	1,06	2200	MWX

879 M

Catena curvilinea
Sideflexing chain / Kurvengängige Scharnierbandkette

Pins: Ferritic Stainless Steel | Backflex radius min.: 50 mm

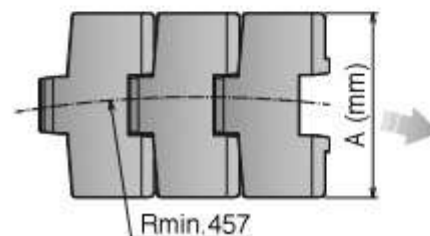
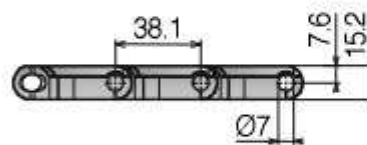
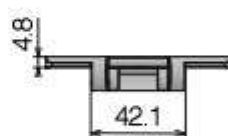

Magnetic System

10 feet
3.048 m
80 links

pg. 90-91/104

pg. 111->123

pg. 464->471

Article-Nr.	ref.	A (Plate Width) mm	R mm	Weight kg/m	Max working load (N)	Material
11240102	LF 879 M K325	82,5	457	1,05	2200	LF
11240105	LF 879 M K450	114,3	457	1,15		
11240302	MX 879 M K325	82,5	457	1,05	1750	MX
11240305	MX 879 M K450	114,3	457	1,15		
11242502	MPX 879 M K325	82,5	457	1,05	2200	MPX
11242505	MPX 879 M K450	114,3	457	1,15		
11241602	DKM 879 M K325	82,5	457	1,05	2200	DKM
11241605	DKM 879 M K450	114,3	457	1,15		
11241702	MWX 879 M K325	82,5	457	1,05	2200	MWX
11241705	MWX 879 M K450	114,3	457	1,15		

879 TAB

Catena curvilinea
Sideflexing chain / Kurvengängige Scharnierbandkette

Pins: Stainless Steel | Backflex radius min.: 50 mm

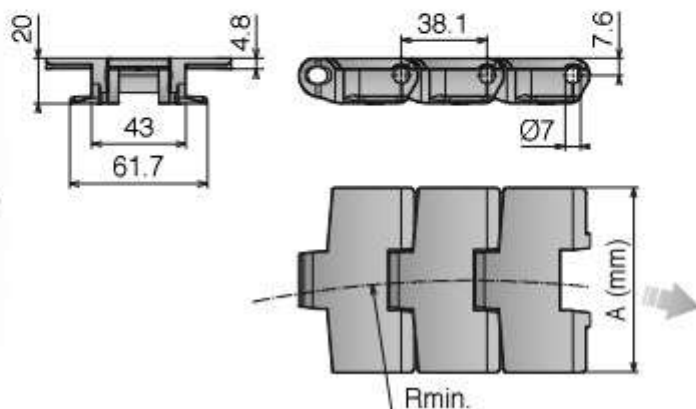

Tab System

10 feet
3.048 m
80 links

pg 90-91/104

pg 157/162

pg 464-471

Article-Nr	Ref.	A (Plate Width) mm	R mm	Weight kg/m	Max working load (N)	Material
11250102	LF 879 TAB K325	82,5	457	1,01	2200	LF
11250105	LF 879 TAB K450	114,3	610	1,13		
11250302	MX 879 TAB K325	82,5	457	1,01	1750	MX
11250305	MX 879 TAB K450	114,3	610	1,13		
11252502	MPX 879 TAB K325	82,5	457	1,01	2200	MPX
11252505	MPX 879 TAB K450	114,3	610	1,13		
11251602	DKM 879 TAB K325	82,5	457	1,01	2200	DKM
11251605	DKM 879 TAB K450	114,3	610	1,13		
11251702	MWX 879 TAB K325	82,5	457	1,01	2200	MWX
11251705	MWX 879 TAB K450	114,3	610	1,13		

888 Catena curvilinea
Sideflexing chain / Kurvengängige Scharnierbandkette

Pins: Stainless Steel | Backflex radius min.: 40 mm

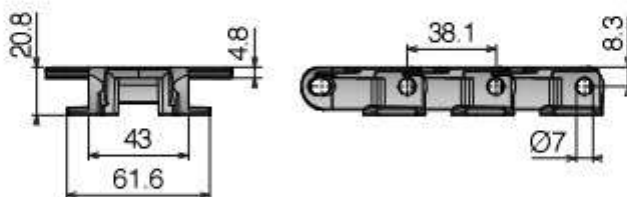

W80

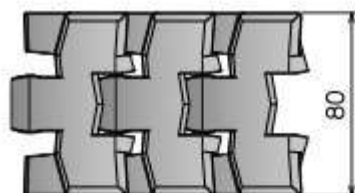

W140

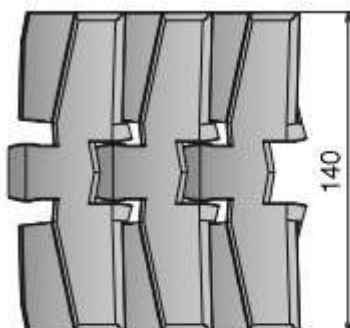

W200

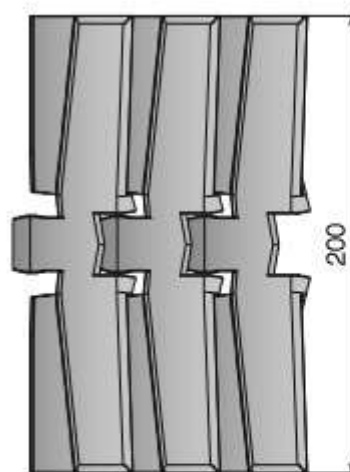

Tab System

10 feet 3.048 m
 80 links
 pg 90-91
 pg 157/162
 pg 464-471

Article-Nr.	Ref.	A (Plate Width) mm	R mm	Weight kg/m	Max working load (N)	Material
11700120	LF 888 W140	140,0	500	1,32	2200	LF
11700121	LF 888 W200	200,0	500	1,62		

Europa
Guipúzcoa
Donostia-San Sebastián
Guipúzcoa

MV TECHNOPLASTIK SOLUTIONS, S.L.
Cº Pilotegi 12, Pb. B-1
20018 DONOSTIA - SAN SEBASTIÁN (Guipúzcoa)
943325483 / 646151126

